

Simplified & rapid adjustment module for CCD monitoring.

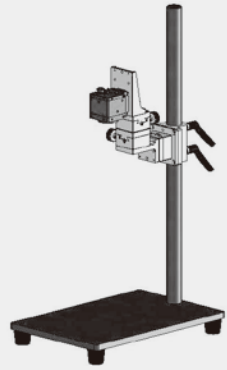

Measuring module for membrane thickness of transparent material.

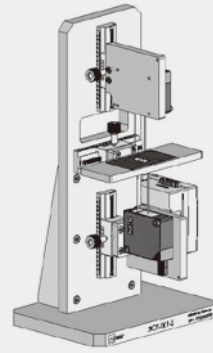

Multiple axes module for Universal fine tuning.

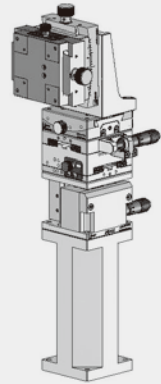

Multi-axes, micro-adjustment module.

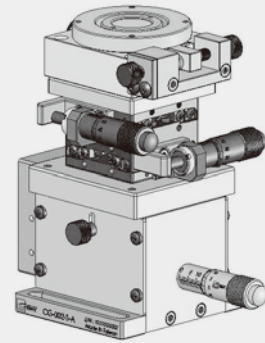

Micro-alignment module of CCD fabricated equipment.

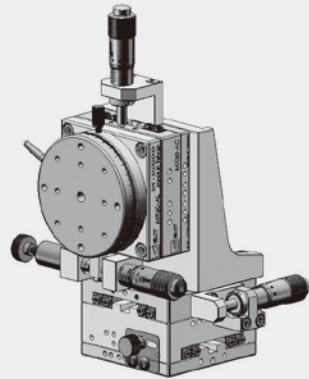

Micro-alignment module for AOI system.

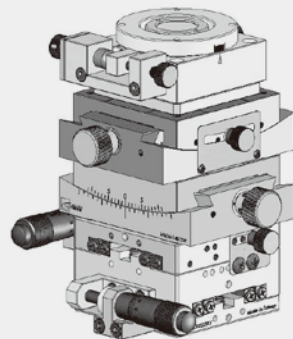

XYR-axis alignment stage module.

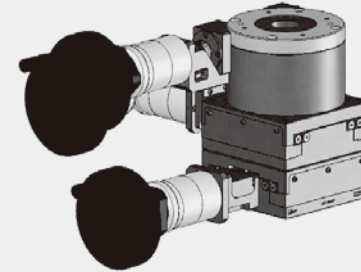

LED wafer characteristic inspection stage module.

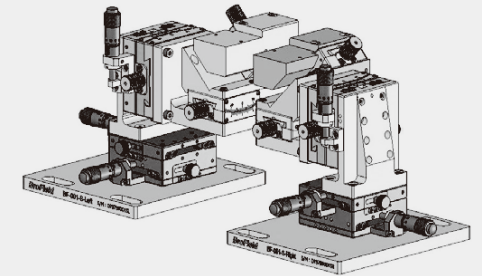

Profile measuring module.

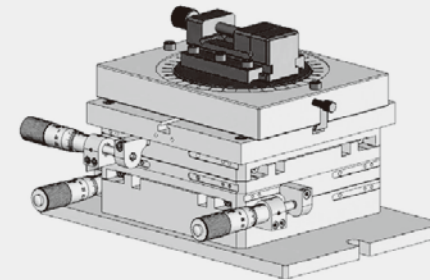

Stage module for surface roughness measuring.

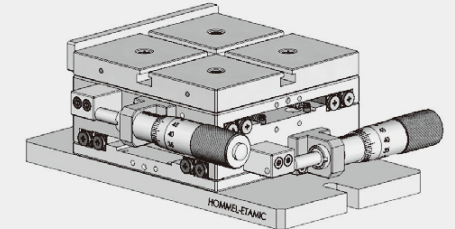

Single axis movement module of large-scale alignment stage.

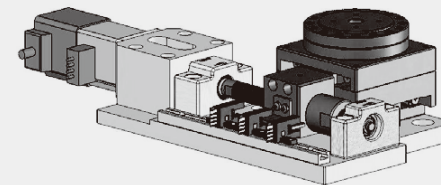

Lathing stage module equipped with mini-size motors

